

## Watchdog 15

### Features

- A** On-board temperature & humidity sensor  
Operating range: -20°C to 85°C
- B** 2 digital sensor inputs
- C** Ethernet port / Power over Ethernet (Watchdog 15 P only)
- D** DC connection jack
- E** Integrated mounting bracket

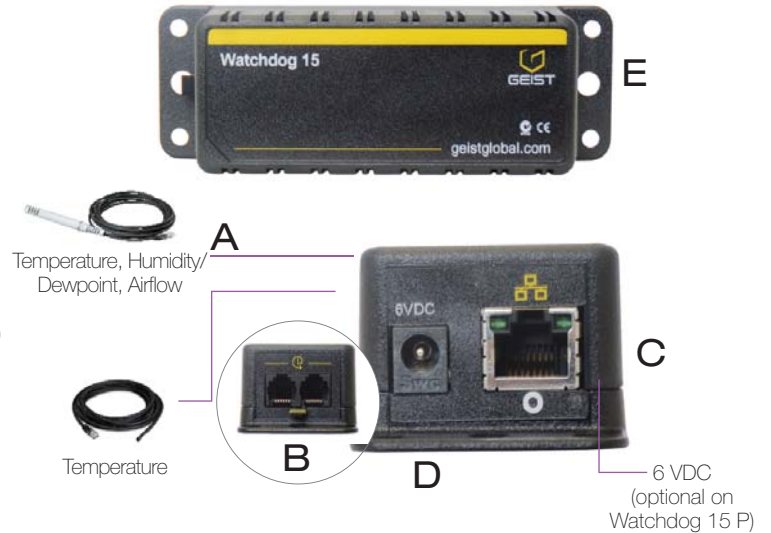

### Description

This self-contained environment monitor has an on-board temperature/humidity sensor. Up to four plug-and-play digital sensors can be connected using a standard splitter. The Watchdog 15 has a built-in web server, allowing remote access to the device.

From a secure web interface, users can keep an eye on remote conditions. Environment measurements are logged and graphed for trending and capacity management. If alarm thresholds are breached, the Watchdog 15 sends alerts via email, email-to-SMS and SNMP traps.

The Watchdog 15 connects to an ethernet network. Simple to install and use, no special software other than a standard web browser is needed to access and configure the device. The Web interface supports up to four IP cameras (not included), giving a quick view of remote conditions, especially useful in event the of an alarm.

Compact and light, the Watchdog 15 offers a variety of mounting options and is perfect for tight installations. A Power over Ethernet (PoE) option is available that can be used to simplify wiring (Watchdog 15 PoE only).

### Watchdog 15

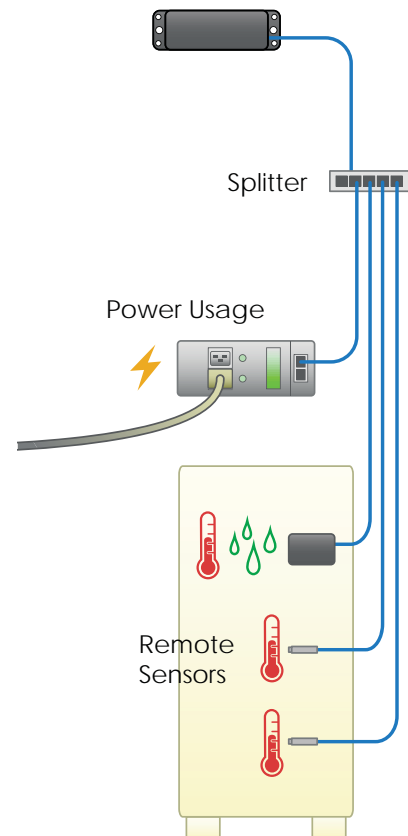

Using a splitter, the Watchdog 15 supports up to four external sensors.

# Watchdog 15

## Specifications

On-Board Sensors	
🌡️ Temperature	
Range	-20 to 85°C
Accuracy (typical)	± 0.3°C
Accuracy (minimum)	see graph
💧 Relative Humidity	
Range	0 to 100% RH
Accuracy (typical)	± 2.0% RH
Accuracy (minimum)	see graph
Dewpoint	Calculated value, based on temperature & humidity

External Sensors	
Digital Sensor Ports	2
Max Digital Sensor Capacity	4

Hardware Features	
Ethernet	10/100
Power	
Input	6 - 12 VDC
Power Supply Options	North American, British, Universal, None
Power Over Ethernet	IEEE802.3af (Watchdog 15 P Only)
"Reset" Button	Clear IP address & passwords, or restore all to factory defaults
Physical	
Dimensions (WxHxD)	5.22" (13.26 cm) x 1.72" (4.37 cm) x 1.29" (3.27 cm)
Weight	1 lb (0.45 kg)
Mounting	see diagram

Firmware	
Real Time Sensor Data Feeds	GUI, SNMP, XML
Environment Monitoring	Logging & Graphing, CSV Data Logs, Event Log†, Interface with IP Surveillance Cameras
Alarms	Alarm Escalations, Alarm Repeat & Delay, Business Hours†
Web Access	Encryption via TLS/SSL (HTTPS), 3 Access Account Levels
SNMP Support	Versions ( v1, v2c, v3† ), Trap Alerts ( Trip / Clear )
Email	Email & Emails-to-SMS Alerts, Periodic Email Status Reports†, ESMTP Authentication, SSL/TLS Encryption
Localization	Multiple Languages†, Display in Metric or US Measurements
Protocols	IPv6†, IPv4, HTTP / HTTPS, DHCP, NTP, Syslog, Ping
Additional Features	Friendly Names Per Sensor, Configuration Cloning†, Remote Configuration & Firmware Updates

Warranty	1 Year Standard Warranty
----------	--------------------------

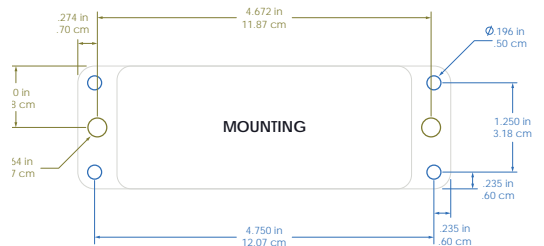
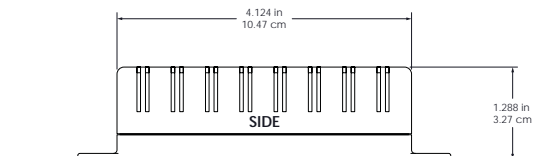
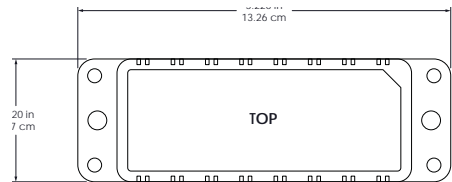
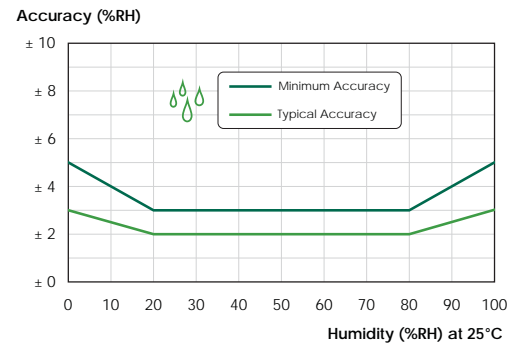
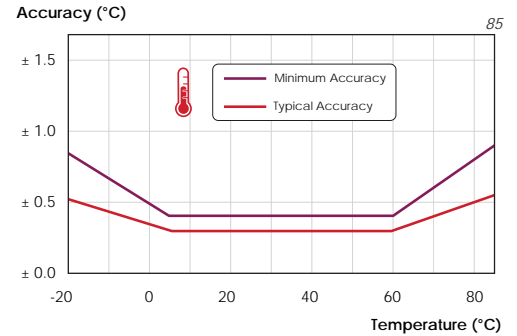

### Compliance

The Watchdog15 carries the CE Mark and complies with EN 55022 Class A, FCC Part 15 Class B, and EN 55024 requirements.



Please note the information contained herein is for informational purposes only. Technical claims listed depend on a series of technical assumptions. Your experience with these products may differ if you operate the products in an environment, which is different from the technical assumptions. Geist reserves the right to modify these specifications without prior notice. Geist makes no warranties, express or implied, on the information contained in this document.

10014101

### Geist Americas

800.432.3219  
geistglobal.com

Geist DCIM  
1.877.449.4150  
geistglobal.com

### Geist Europe

+44 (0) 1823 275100  
geistglobal.com

### Geist Asia

China  
+86.755.86639505  
geistglobal.com

Hong Kong  
+852 90361927  
geistglobal.com